



PRODUCT DESCRIPTION

Indoor and Outdoor luminaire constructed of :

**NOTES**  
Luminaires are supplied with a glass diffuser

- Painted die-cast aluminium body
  - Aluminium reflector
  - EPDM gasket
- Stainless steel screws
- Painting using high resistance to UV and corrosion polyester powders

DIMENSIONS

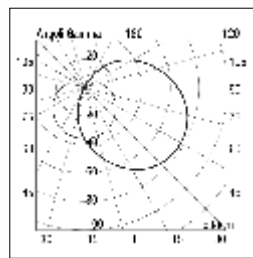

9322.00X

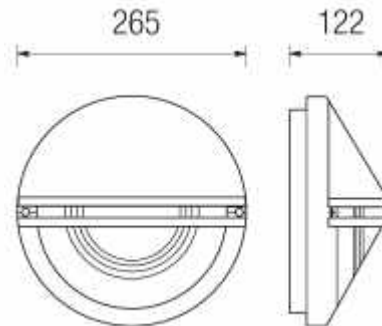

Order Code	Lampholder	Colours
ELMA/W	E27	White
ELMA/B	E27	Black
ELMA/S	E27	Silver

TECHNICAL DATA

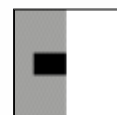

Recessed wall version

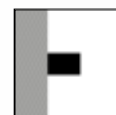

Wall mounting

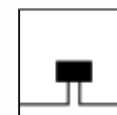

Double power supply entry cables

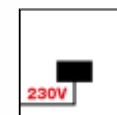

LED:  
The luminaire is supplied with a Full Range 100/240V 50/60Hz built-in transformer.



CS 93:  
ACCESSORY  
Technopolymer holder to be recessed flush with the wall before the installation of the luminaire.  
Ψ mm 260 h mm 60

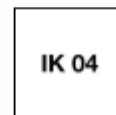

Glass diffuser  
Impact Energy (J):  
0,5

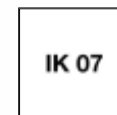

Polycarbonate diffuser  
Impact Energy (J):  
2