



PRODUCT DESCRIPTION

Indoor and Outdoor luminaire constructed of :

NOTES
Luminaires are supplied with a glass diffuser

- Painted die-cast aluminium body
- Aluminium reflector
- EPDM gasket
- Stainless steel screws
- Painting using high resistance to UV and corrosion polyester powders

DIMENSIONS

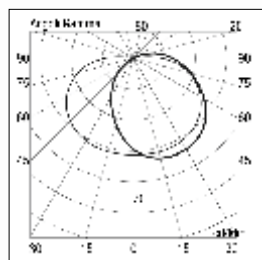

3083,95X

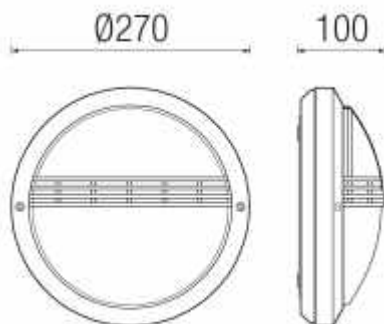

Order Code	Lampholder	Colours
PAMAL / W	E27	White
PAMAL / W	E27	Black
PAMAL / W	E27	Silver

TECHNICAL DATA

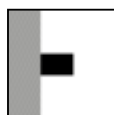

Wall mounting

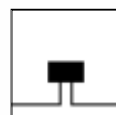

Double power supply entry cables

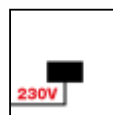

LED:
The luminaire is supplied with a Full Range 100/240V 50/60Hz built-in transformer.

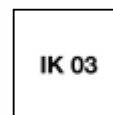

Glass diffuser
Impact Energy (J):
0,35

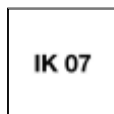

Polycarbonate diffuser
Impact Energy (J):
2

QUALITY MARKS

